

















ASSEMBLY INSTRUCTIONS

95132 / 95133

HARDWARE LIST

NO	SKETCH	SKETCH	SIZE	QTY
1		Flat Washer	M8*16mm	23PCS
2		Spring Washer	M8	23PCS
3		Bolt	25mm*M8	12PCS
4		Allen Key	M5	1PC
5		Bolt	45mm*M8	11PCS
6		Wood Screw	35mm*M8	6PCS
7		Screw Driver		Not provided

PARTS LIST

NO	SKETCH	DESCRIPTION	QTY
A		Headboard	1PC
B1		Left Headboard Leg	1PC
B2		Right Headboard Leg	1PC
C		Connecting Bar	2PCS
D		Footboard	1PC
E		Slat Support Leg	3PCS
F		Headboard & Footboard Leg	4PCS
G		Flat Slat	3PCS
H		Side Rail	2PCS

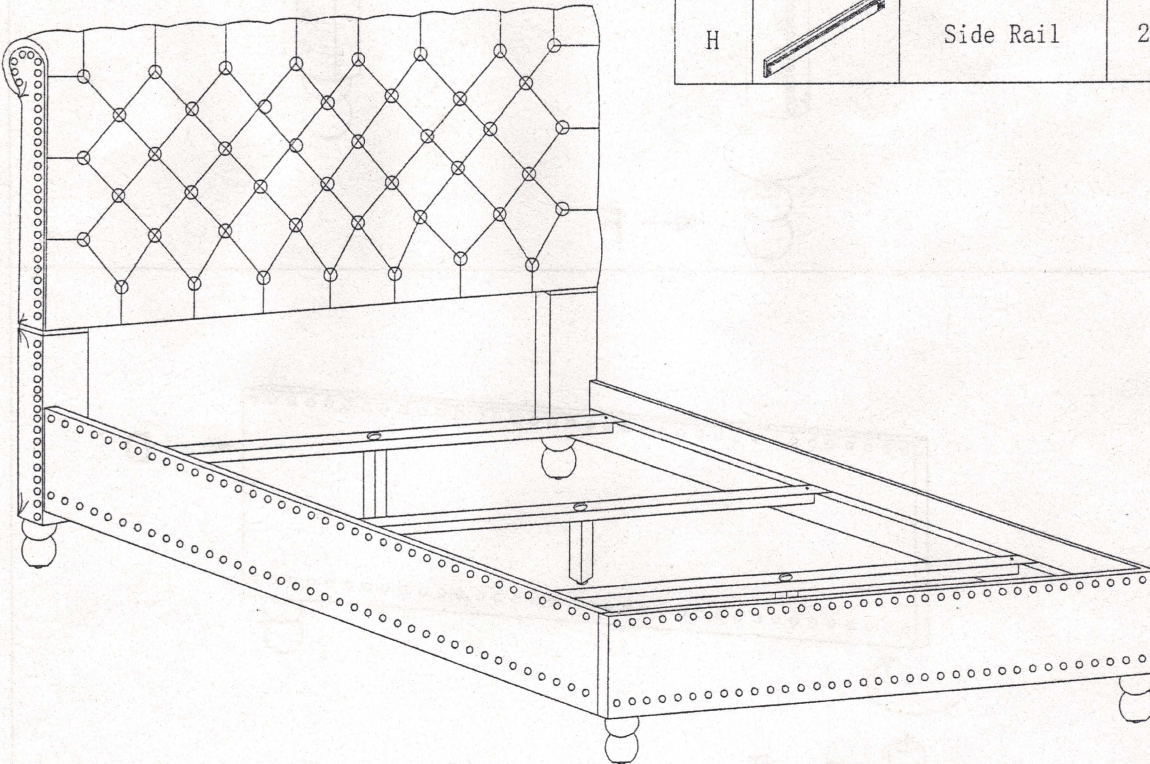

Step 1.

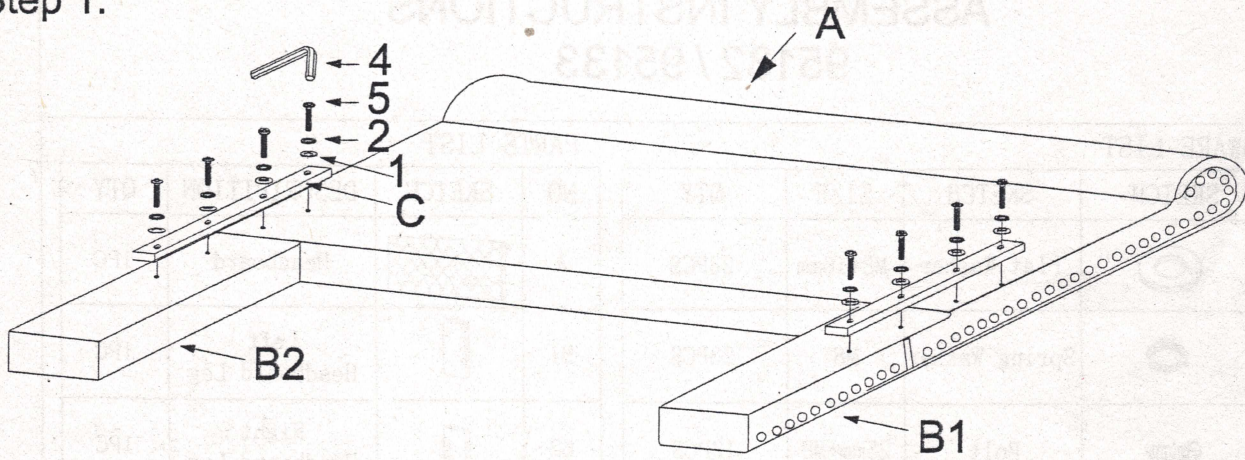

Step 2.

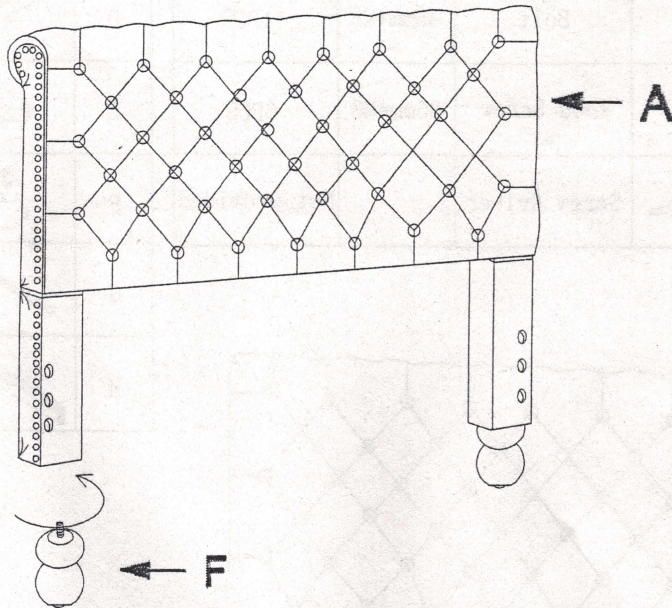

Step 3.

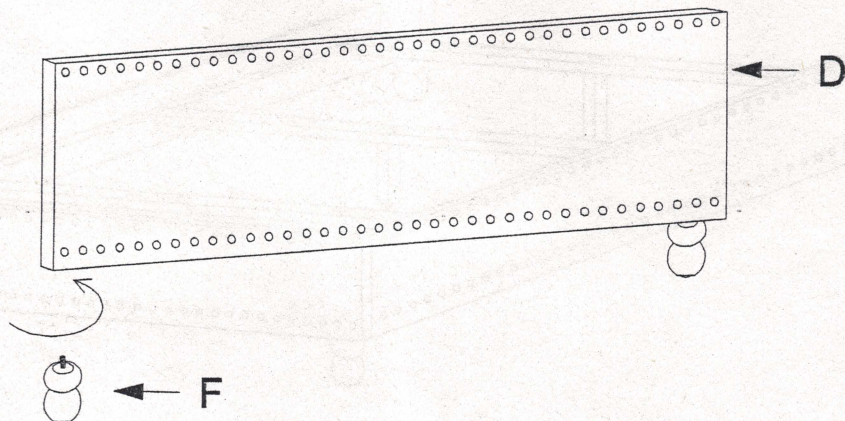

Step 4.

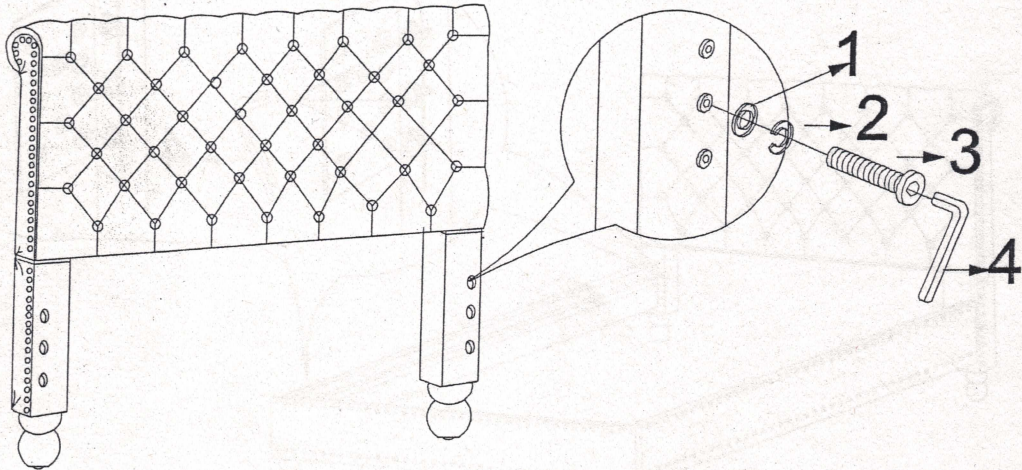

Step 5.

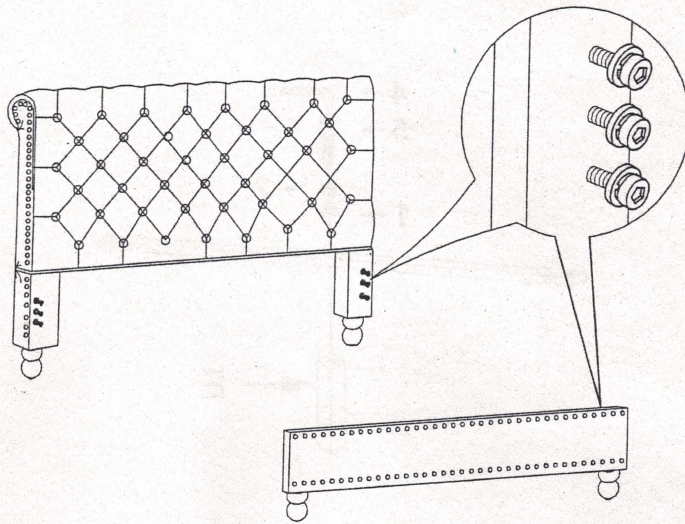

Step 6.

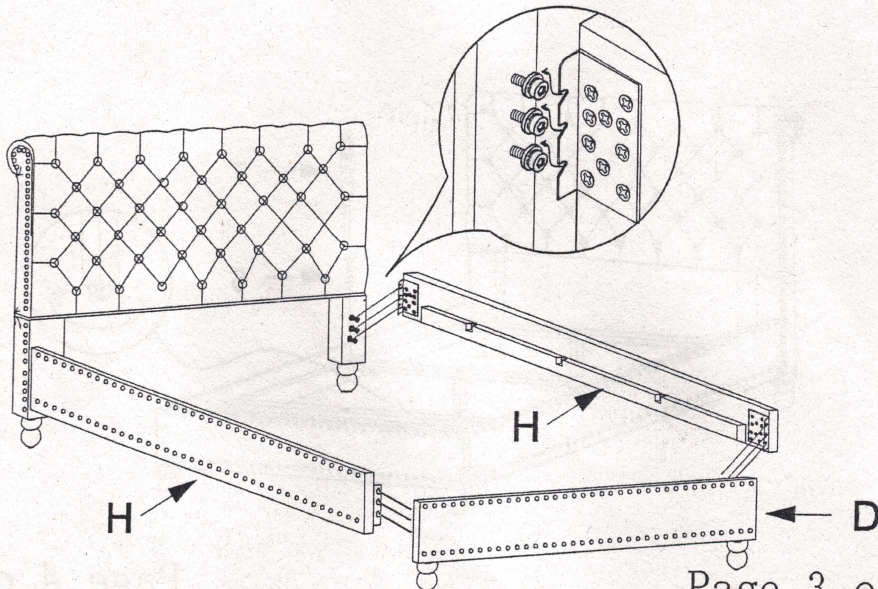

Step 7

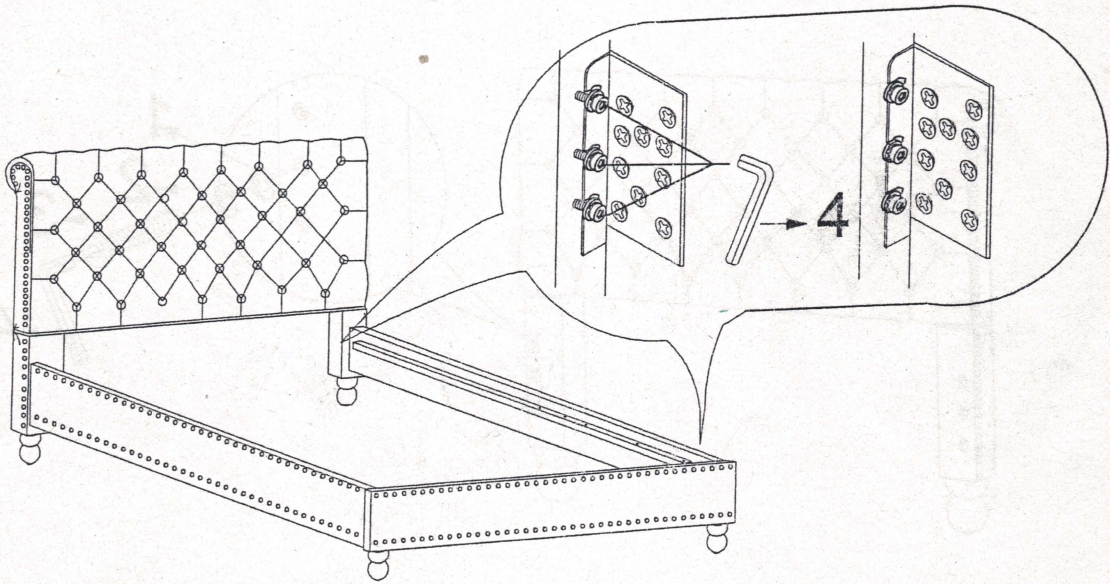

Step 8.

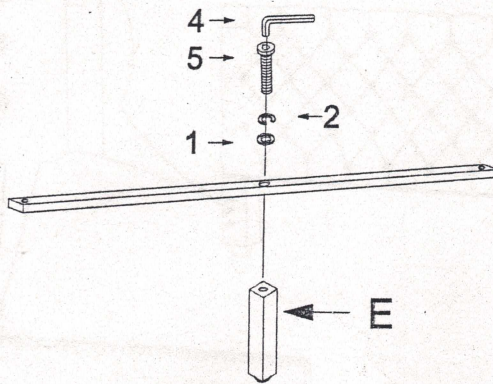

Step 9.

